

Technical requirement 技术参数:

1. Electrical Characteristics Test 电气性能检验

- 1.1 Products 100% for electrical test. 成品100%电性测试.
- 1.2 Insulation resistance: No less than 100MΩ of 500V DC/0.4S.
绝缘阻抗: 大于或等于100MΩ 500V DC/0.4S.
- 1.3 Dielectric strength 耐电压

- 1.3.1 Between two conductors 1500_0^{200} V AC for 1.0s Trip-current 1.0mA max.
导体与导体之间 1500_0^{200} V AC /1秒,漏电流1.0mA(max).
- 1.3.2 Between conductor and body 2500_0^{200} V AC for 1.0s - Trip current 1.0mA max.
导体与本体之间 2500_0^{200} V AC /1秒,漏电流1.0mA(max).

2. Mechanical Characteristics Test 机械性能检验

2.1. Withdrawal force 拔出力

- 2.1.1 For checking each PIN independently from the standard-gauge below 1.5N(Min) Keep for 3S or more.
标准量规对连接器插孔单PIN保持力为最小1.5N保持3秒以上.
- 2.1.2 For checking Integral withdrawal force 50N(Max) from maximum standard gauge. 标准量规(最大值)检查整体拔出力 50N(最大).

3. Finished product conditions 成品状态

- 3.1 The attachment plug front show the test mark of "T".
插头主视面须有测试标志"T".
- 3.2 The dimension with "x/y" must be control and inspected importantly.
带"x/y"尺寸需重点管控和检验.
- 3.2 The dimension with "*" is required by safty standard .
带"*"尺寸为安规尺寸.

4. Standards 标准

- 4.1 The cord shall comply with UL62. 线材符合UL62
- 4.2 The molded plug shall comply with UL817. 插头符合UL 817.
- 4.3 The molded connector shall comply with UL817, IEC60320-1.
连接器符合UL817, IEC60320-1

5. Environmental requirement 环保要求

- 5.1 Material and product comply with Doc No."QW-Q-043" 《material-and product- of restricted substance control specification.
物料及成品必须符合QW-Q-043 《材料与成品限用物质管理规范》.

Wiring method 接线方式:

J1	cord	J2
E	green	E
L	black	L
N	white	N

REV.	DESCRIPTION	DESIGN	APPROVAL	DATE
A	NEW	H.Q SONG	BG Yang	2014.07.31
B	ECN14-0000022663(增加UL logo)	Betty	BG YANG	2014.12.04
C	Change the customer P/N	DanPeng	XL DENG	2017.07.28
D	ECN18-0000016767(change the shape of plug and connector)	Hongmei	XL DENG	2018.07.03

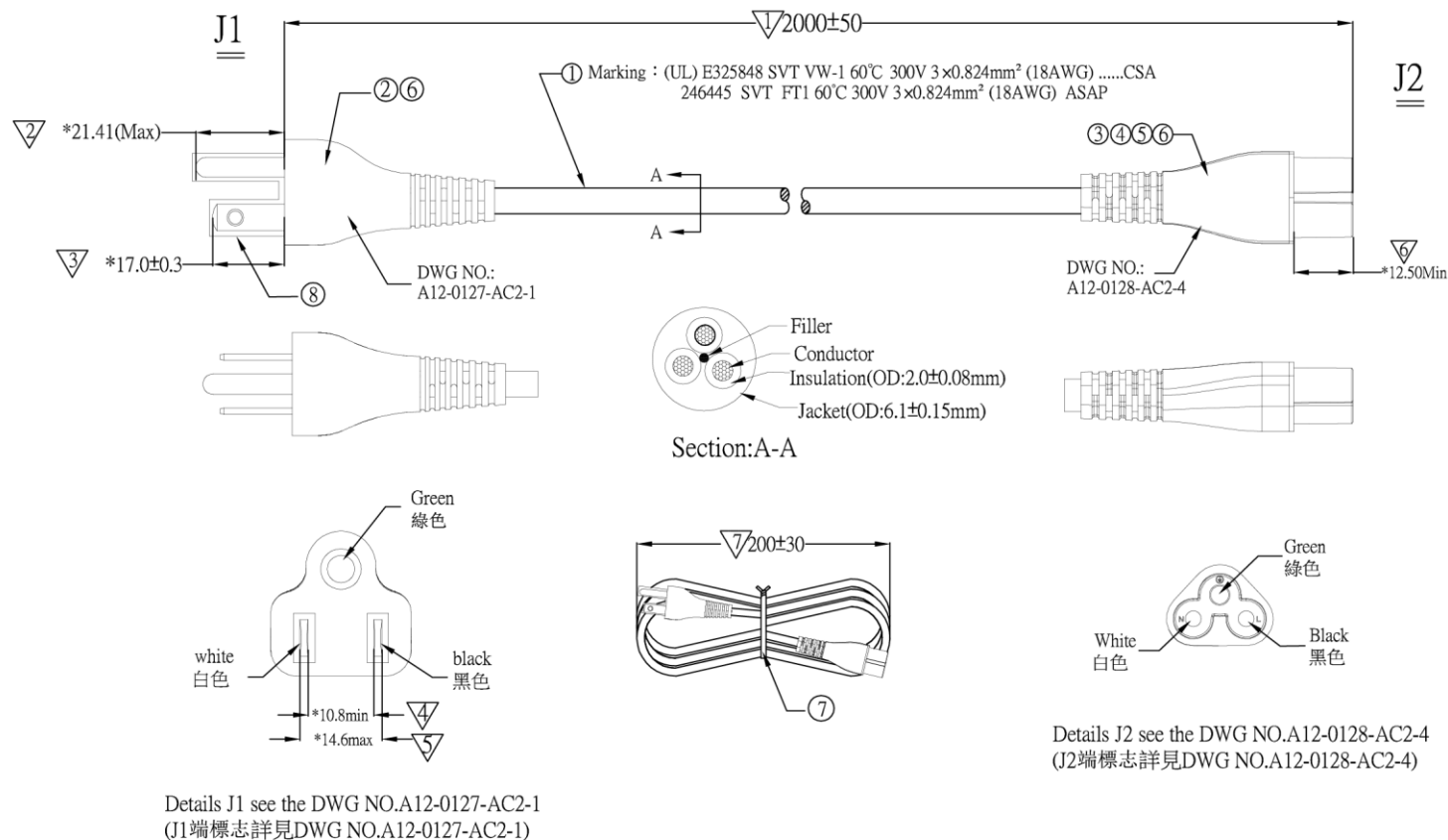

ITEM	NAME	DESCRIPTION	UNIT	QTY
⑧	PIN COVER	Protecting cover for plug pins, White	pcs	1
⑦	TIE	Black PE tie, complying with RoHS.	pcs	1
⑥	PVC PELLET	55P black PVC pellets meeting RoHS and UL94 V-0.	g	
⑤	TERMINAL	O type contact terminal, phosphor copper. size: 0.4*19.2*13.2mm	pcs	1
④	TERMINAL	O type contact terminal, phosphor copper. size: 0.4*17.6*13.1mm	pcs	2
③	HOUSING	Housing for C5 connector, PBT, UL94V-0 BLACK	pcs	1
②	INSERT	UL two poles insert with earthing, PBT 94V-0, black, copper, nickel-plated.	pcs	1
①	POWER CORD	SVT 18AWG/3C 60°C black	mm	NA

X.±	X.°±	UNITS
.X±	.X°±	mm
.XX±	.XX°±	MATL
.XXX±	.XXX°±	
THESE DRAWINGS AND SPECIFICATIONS ARE THE PROPERTY OF ASAP TECHNOLOGY(JIANGXI)CO., LIMITED AND SHALL NOT BE REPRODUCED, COPIED OR CUED IN ANY MANNER WITHOUT THE PRIOR WRITTEN CONSENT OF ASAP TECHNOLOGY(JIANGXI)CO., LIMITED.		
FINISH		
Q'TY		

PART NO: L8CAC014-DT-R		TITLE: UL 3P To C5 L2M black		
		DWG NO: L8CAC014-DT-R		
APPD:	XL Deng	SCALE	SHEET	REV.
CHKD:	Guangren Ouyang			
DR:	Hongmei Hu			

P/N:42-0555

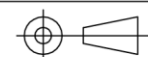

NOTE:
 Technical Requirement: The dimension with " * " is for safety standard.

REV.	DESCRIPTION	DESIGN	APPROVAL	DATE
A	NEW	JING LIU	QS LIU	2017.9.27

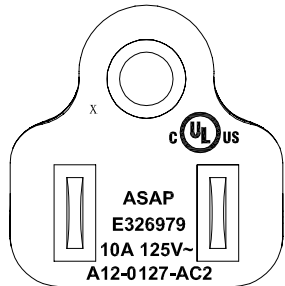
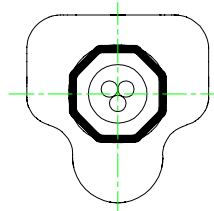
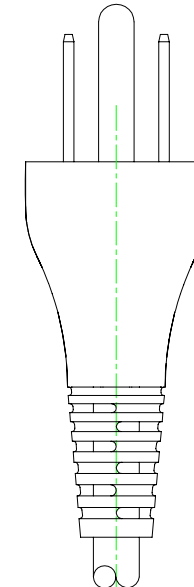
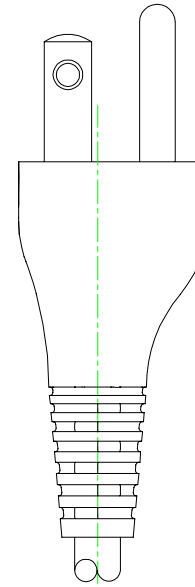
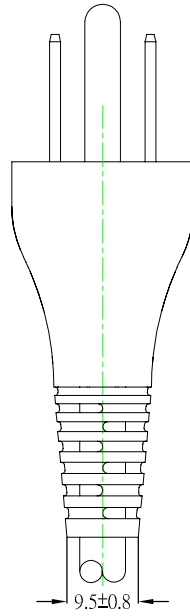
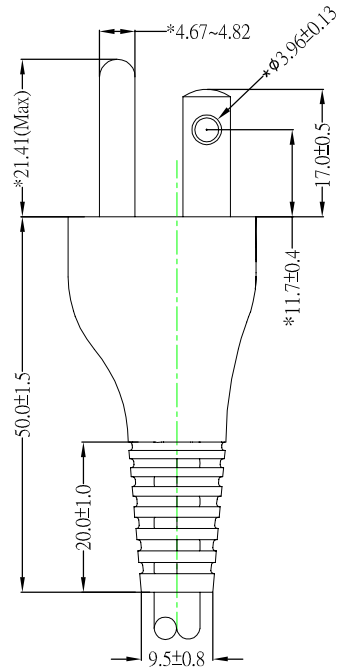
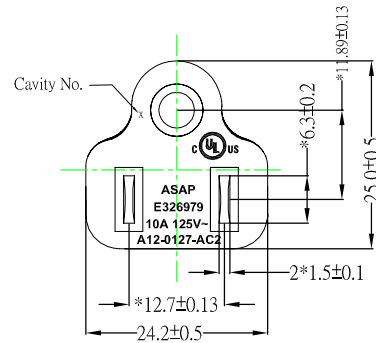
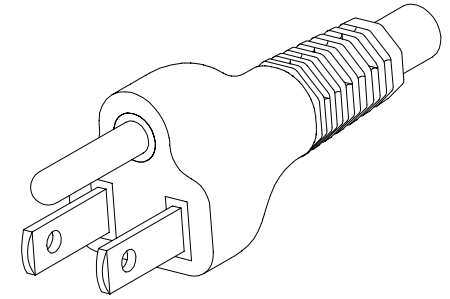

Marking

X. :±0.6	X.° :±1°	DWG TYPE: PRODUCT DRAWING	TITLE: UL 5-15P Three Pin PLUG			
.X :±0.4	.X° :±0.6°					
.XX:±0.10	.XX°:±0.3°	MOUID NO: AC-P0127-x	DWG NO: A12-0127-AC2-1			
UNITS	mm	APPD: 欧阳光仁				
THESE DRAWINGS AND SPECIFICATIONS ARE THE PROPERTY OF LUXSHARE-ICT AND SHALL NOT BE REPRODUCED, COPIED OR CUED IN ANY MANNER WITHOUT THE PRIOR WRITTEN CONSENT OF LUXSHARE-ICT		CHKD: 刘秋顺		SCALE	SHEET	REV.
		DRAW: 刘景		NONE	1/1	A

1	SVT 18AWGX3C OD:6.1	Round Cable
NO.	SPECIFICATION	Remark

NOTE:
 Technical Requirement: The dimension with " * " is for safety standard.

REV.	DESCRIPTION	DESIGN	APPROVAL	DATE
A	NEW	JING LIU	QS LIU	2017.9.27

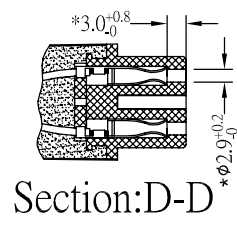
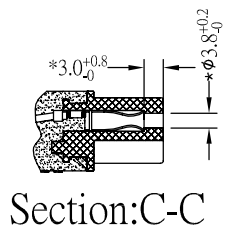
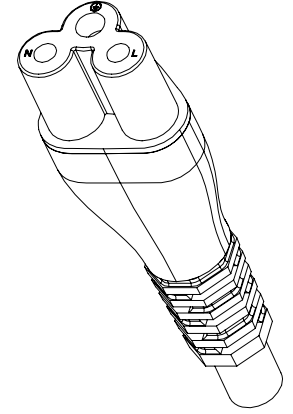
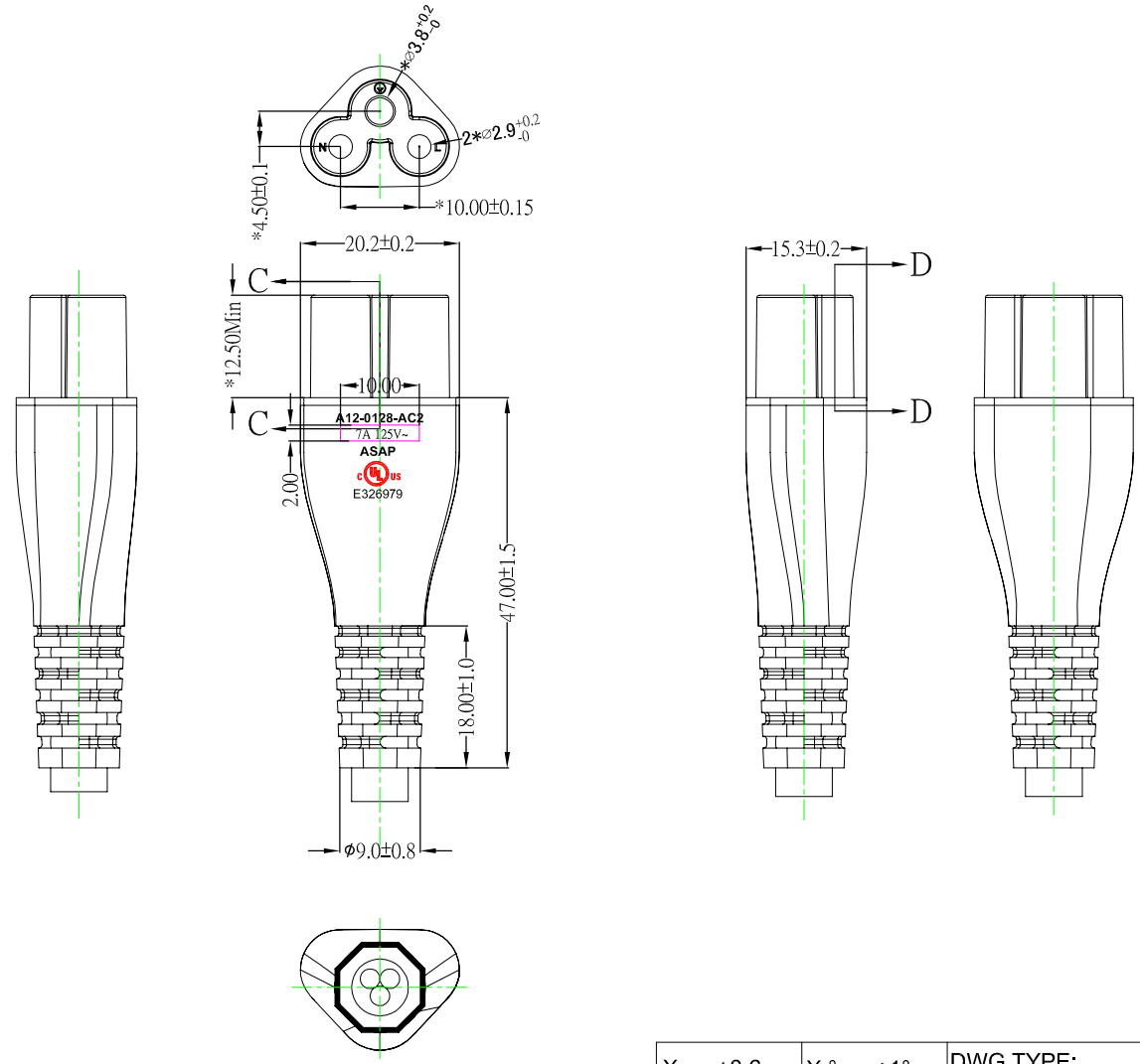

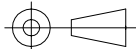
X. :±0.6	X.° :±1°	DWG TYPE: PRODUCT DRAWING	TITLE: UL C5 Connector			
.X :±0.4	.X° :±0.6°					
.XX:±0.10	.XX°:±0.3°	MOUID NO: AC-C0128-x	DWG NO: A12-0128-AC2-4			
UNITS	mm	APPD: 邓小兰				
THESE DRAWINGS AND SPECIFICATIONS ARE THE PROPERTY OF LUXSHARE-ICT AND SHALL NOT BE REPRODUCED, COPIED OR CUED IN ANY MANNER WITHOUT THE PRIOR WRITTEN CONSENT OF LUXSHARE-ICT		CHKD: 刘秋顺		SCALE	SHEET	REV.
		DRAW: 伍小强		NONE	1/1	A

SVT 18/3C	OD:6.1	Round Cable
NO.	SPECIFICATION	Remark

